

DATA SHEET

SKY67110-396LF: 0.30-0.75 GHz High Linearity, Active Bias Low-Noise Amplifier

Applications

- CDMA, WCDMA, ISM, TETRA, RFID, LMR, and LTE cellular infrastructures
- Ultra low-noise systems

Features

- Ultra Low Noise Figure: 0.65 dB @ 0.45 GHz
- High temperature operation to +105 °C
- High gain: 21 dB @ 0.45 GHz
- IIP3: +16 dBm @ 0.45 GHz
- High IP1dB performance: +1 dBm @ 0.45 GHz
- Adjustable supply current and gain
- Temperature and process-stable active bias
- Miniature DFN (8-pin, 2 x 2 mm) package (MSL1 @ 260 °C per JEDEC J-STD-020)



Skyworks Green™ products are compliant with all applicable legislation and are halogen-free. For additional information, refer to Skyworks Definition of Green™, document number SQ04-0074.

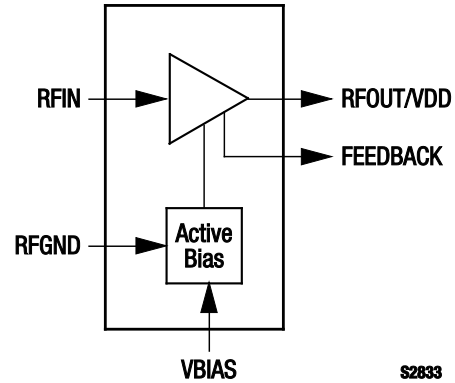

Figure 1. SKY67110-396LF Block Diagram

Description

The SKY67110-396LF is GaAs, pHEMT Low-Noise Amplifier (LNA) with an active bias and high linearity performance. The advanced GaAs pHEMT enhancement mode process provides excellent return loss, low noise, and high linearity performance.

The internal active bias circuitry provides stable performance over temperature and process variation. The device offers the ability to externally adjust supply current and gain. Supply voltage is applied to the RFOUT/VDD pin through an RF choke inductor. Pin 4 (VBIAS) should be connected to RFOUT/VDD through an external resistor to control the supply current. The RFIN and RFOUT/VDD pins should be DC blocked to ensure proper operation. Pin 5 (FEEDBACK) is connected through an RC network to externally adjust the gain of the device without affecting the Noise Figure (NF) of the LNA.

The SKY67110-396LF operates in the frequency range of 0.30 to 0.75 GHz with proper tuning.

The LNA is manufactured in a compact, 2 x 2 mm, 8-pin Dual Flat No-Lead (DFN) package. A functional block diagram is shown in Figure 1. The pin configuration and package are shown in Figure 2. Signal pin assignments and functional pin descriptions are provided in Table 1.

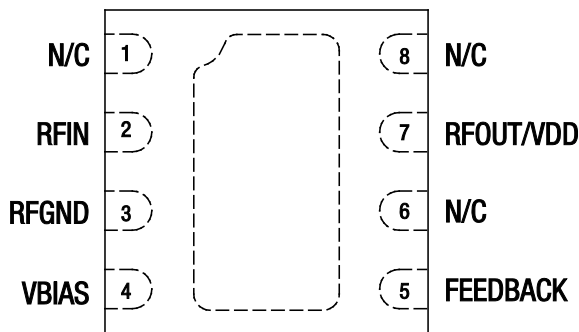

S2786

Figure 2. SKY67110-396LF Pinout – 8-Pin DFN (Top View)

Table 1. SKY67110-396LF Signal Descriptions

Pin #	Name	Description	Pin #	Name	Description
1	N/C	No connection. May be connected to ground with no change in performance.	5	FEEDBACK	LNA external gain control. Connect to RFOUT using a series RD network.
2	RFIN	RF input. DC blocking capacitor required.	6	N/C	No connection. May be connected to ground with no change in performance.
3	RFGND	RF ground. Connect to ground through a capacitor.	7	RFOUT/VDD	RF output. Apply VDD through RF choke inductor. DC blocking capacitor required.
4	VBIAS	LNA supply current. Connect through series resistor to VDD or bias separately through DC header, pin 4.	8	N/C	No connection. May be connected to ground with no change in performance.

Table 2. SKY67110-396LF Absolute Maximum Ratings

Parameter	Symbol	Minimum	Typical	Maximum	Units
Supply voltage	V _{DD}			5.5	V
RF input power	P _{IN}			+20	dBm
Storage temperature	T _{STG}	-65	+25	+150	°C
Thermal resistance	θ _{JC}		62.2		°C/W
Operating temperature	T _A	-40	+25	+105	°C
Junction temperature	T _J			+150	°C
Electrostatic Discharge: Charged Device Model (CDM), Class 4 Human Body Model (HBM), Class 1A Machine Model (MM), Class A	ESD			1000 250 25	V V V

Note: Exposure to maximum rating conditions for extended periods may reduce device reliability. There is no damage to device with only one parameter set at the limit and all other parameters set at or below their nominal value. Exceeding any of the limits listed here may result in permanent damage to the device.

CAUTION: Although this device is designed to be as robust as possible, Electrostatic Discharge (ESD) can damage this device. This device must be protected at all times from ESD. Static charges may easily produce potentials of several kilovolts on the human body or equipment, which can discharge without detection. Industry-standard ESD precautions should be used at all times.

Electrical and Mechanical Specifications

The absolute maximum ratings of the SKY67110-396LF are provided in Table 2. Electrical specifications are provided in Table 3.

Typical performance characteristics of the SKY67110-396LF are illustrated in Figures 3 through 19.

Table 4 provides noise source pull information versus frequency.

Table 3. SKY67110-396LF Electrical Specifications (Note 1)**(V_{DD} = 5.0 V, I_{DD} = 76 mA, T_A = +25 °C, P_{IN} = -20 dBm, Characteristic Impedance [Z₀] = 50 Ω, Unless Otherwise Noted)**

Parameter	Symbol	Test Condition	Min	Typical	Max	Units
RF Specifications						
Noise Figure (Note 2)	NF	@ 0.45 GHz		0.65	0.90	dB
Small signal gain	S ₂₁	@ 0.45 GHz	20	21		dB
Input return loss	S ₁₁	@ 0.45 GHz	13.0	17.5		dB
Output return loss	S ₂₂	@ 0.45 GHz	12	18		dB
Reverse isolation	S ₁₂	@ 0.45 GHz	25	28		dB
3 rd Order Input Intercept Point	IIP3	@ 0.45 GHz, Δf = 5 MHz, P _{IN} = -20 dBm/tone	+13	+16		dBm
3 rd Order Output Intercept Point	OIP3	@ 0.45 GHz, Δf = 5 MHz, P _{IN} = -20 dBm/tone	+34	+37		dBm
1 dB Input Compression Point	IP1dB	@ 0.45 GHz	-1	+1		dBm
1 dB Output Compression Point	OP1dB	@ 0.45 GHz	+19	+21		dBm
Stability	μ1, μ2	Up to 18 GHz, -40 °C to +105 °C		>1		-
DC Specifications						
Supply voltage	V _{DD}			5.0		V
Supply current	I _{DD}	Set with external resistor	65	76	85	mA

Note 1: Performance is guaranteed only under the conditions listed in this Table.**Note 2:** Board and connector losses have not been de-embedded.

Typical Performance Characteristics

($V_{DD} = 5.0\text{ V}$, $I_{DD} = 76\text{ mA}$, $T_A = +25\text{ }^\circ\text{C}$, $P_{IN} = -20\text{ dBm}$, Characteristic Impedance [Z_0] = $50\ \Omega$, Unless Otherwise Noted)

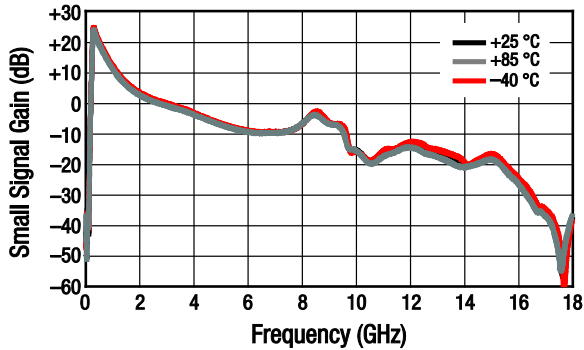

Figure 3. Broadband Gain Response vs Frequency Over Temperature

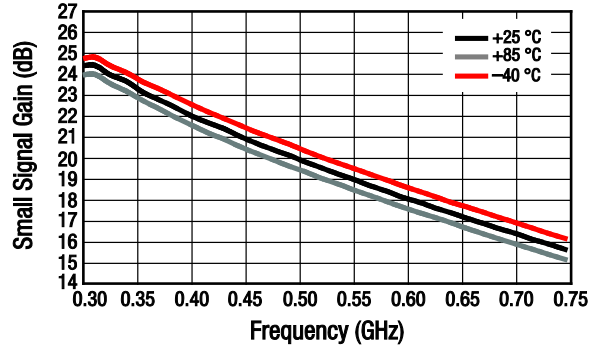

Figure 4. Narrowband Gain Response vs Frequency Over Temperature

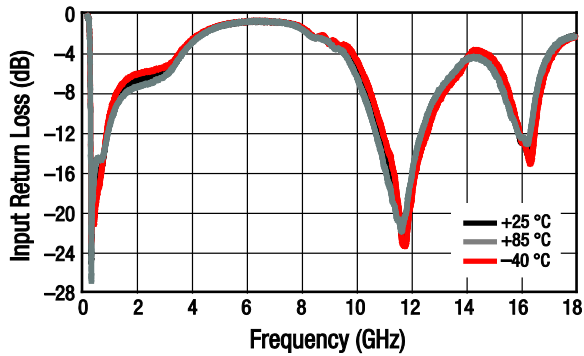

Figure 5. Broadband Input Return Loss vs Frequency Over Temperature

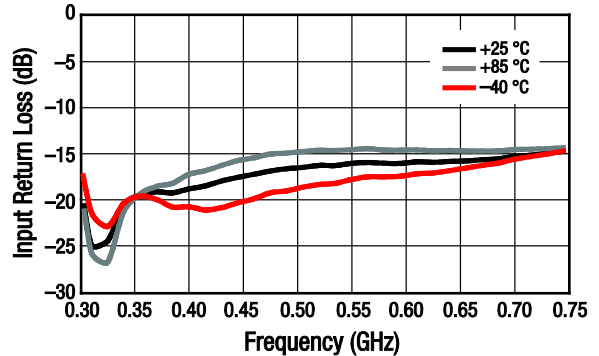

Figure 6. Narrowband Input Return Loss vs Frequency Over Temperature

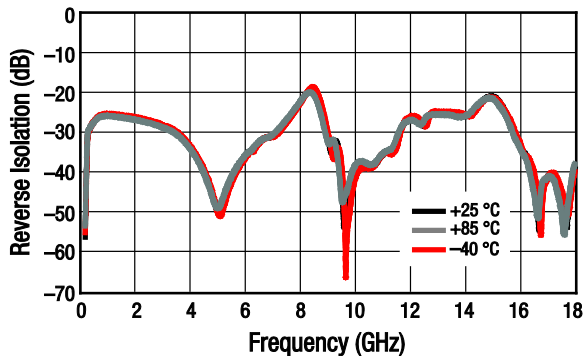

Figure 7. Broadband Reverse Isolation vs Frequency Over Temperature

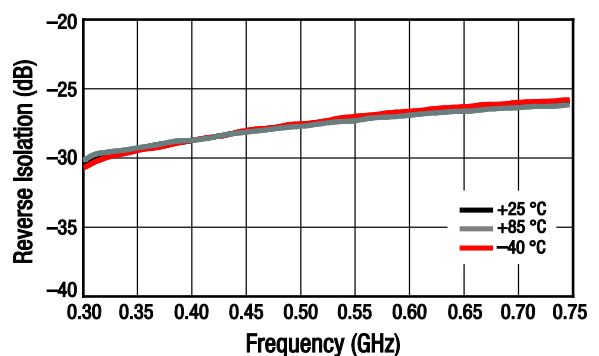

Figure 8. Narrowband Reverse Isolation vs Frequency Over Temperature

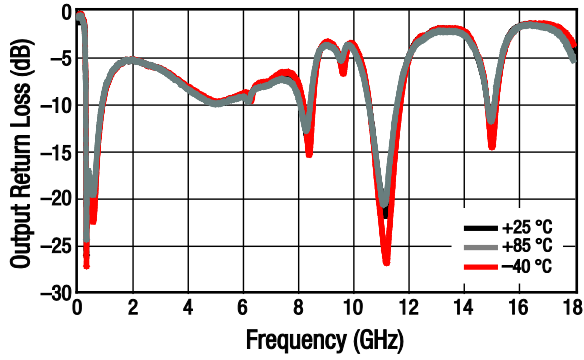

Figure 9. Broadband Output Return Loss vs Frequency Over Temperature

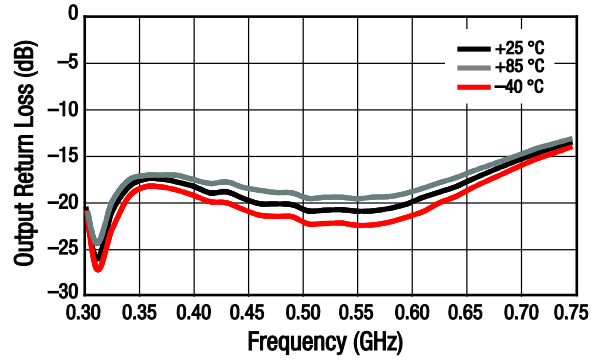

Figure 10. Narrowband Output Return Loss vs Frequency Over Temperature

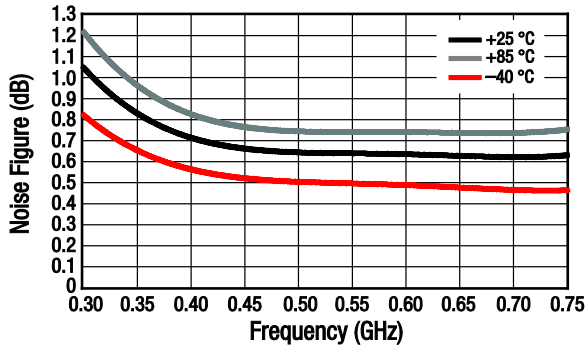

Figure 11. Noise Figure vs Frequency Over Temperature

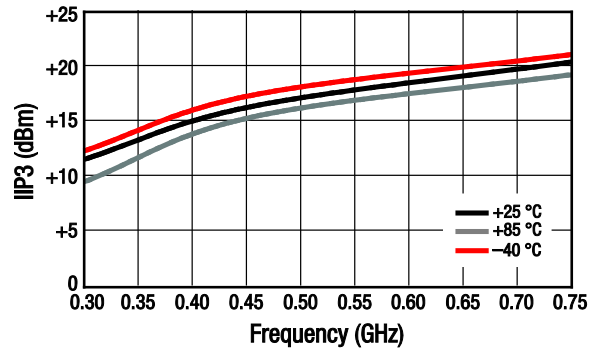

Figure 12. IIP3 vs Frequency Over Temperature

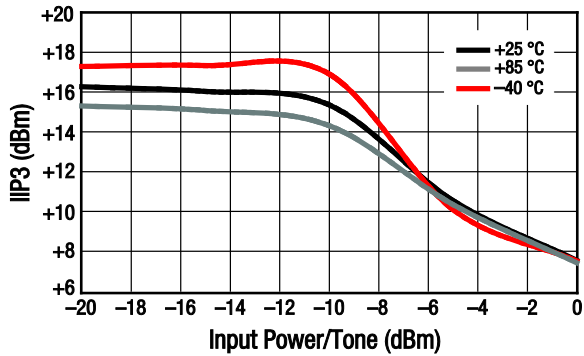

Figure 13. IIP3 vs Input power/Tone @ 0.45 GHz Over Temperature

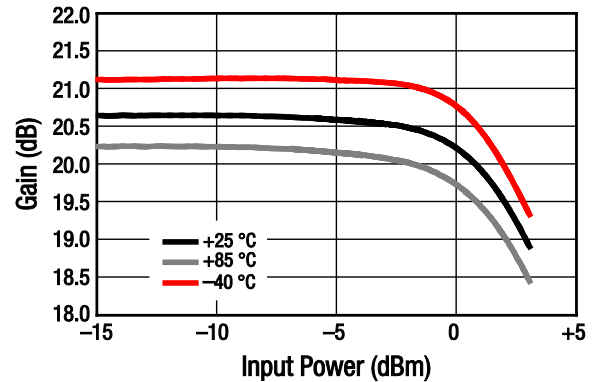

Figure 14. Gain @ 0.45 GHz vs Input Power Over Temperature

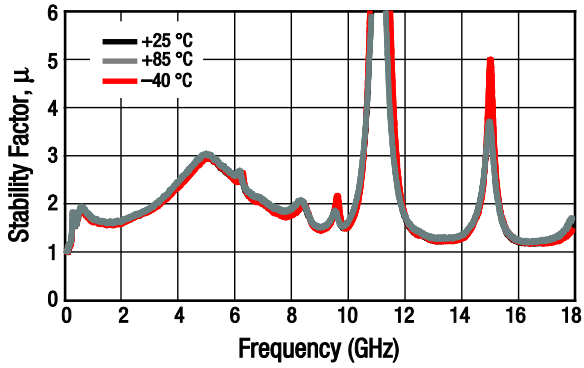

Figure 15. μ Stability vs Frequency Over Temperature

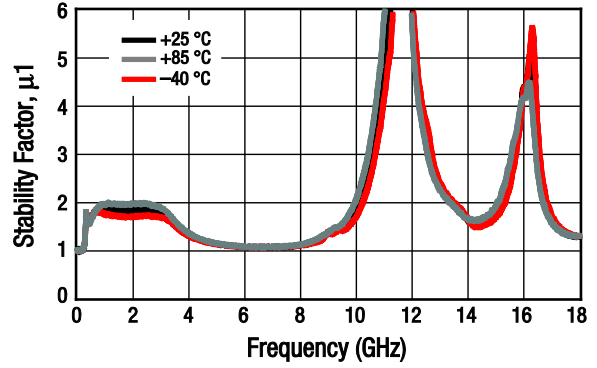

Figure 16. μ_1 Stability vs Frequency Over Temperature

Swept F1 Load Gamma Pull
 Freq = 0.3500 GHz
 TSource: 0.2298 < 78.35

 Gt max = 24.39 dB
 at 0.4813 < 44.08
 5 contours, 1.00 dB step
 (20.00 to 24.00 dB)
 IP3 max = +37.23 dBm
 at 0.3838 < 47.43
 5 contours, +0.50 dBm step
 (+35.00 to +37.00 dBm)
 Specs: OFF

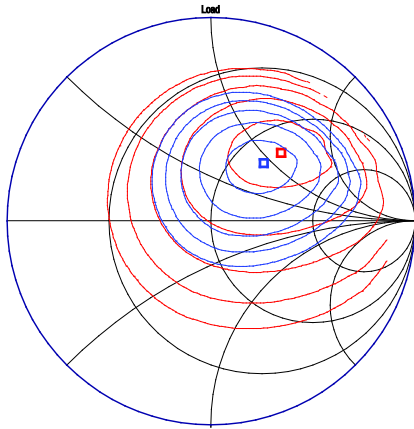

Figure 17. OIP3 Load Pull @ 0.35 GHz, 5 V, 76 mA
 (Input Load = NF Min., -20 dBm/Tone, 5 MHz Spacing)

Swept F1 Load Gamma Pull
 Freq = 0.4500 GHz
 TSource: 0.2046 < 78.80

 Gt max = 22.05 dB
 at 0.5007 < 80.22
 5 contours, 1.00 dB step
 (18.00 to 22.00 dB)
 IP3 max = +38.56 dBm
 at 0.6248 < 99.86
 5 contours, +0.50 dBm step
 (+36.50 to +38.50 dBm)
 Specs: OFF

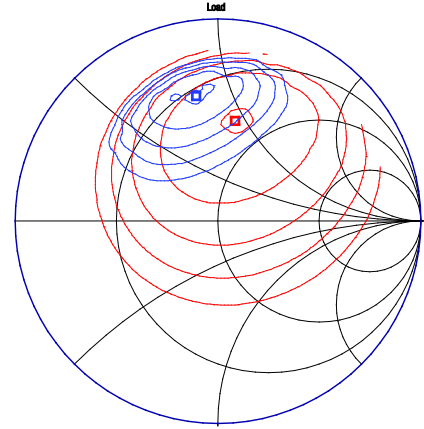

Figure 18. OIP3 Load Pull @ 0.45 GHz, 5 V, 76 mA
 (Input Load = NF Min., -20 dBm/Tone, 5 MHz Spacing)

Swept F1 Load Gamma Pull
 Freq = 0.7500 GHz
 TSource: 0.2090 < 89.02

 Gt max = 16.17 dB
 at 0.5593 < 158.84
 5 contours, 1.00 dB step
 (12.00 to 16.00 dB)
 IP3 max = +38.35 dBm
 at 0.5587 < -172.39
 5 contours, +0.50 dBm step
 (+36.00 to +38.00 dBm)
 Specs: OFF

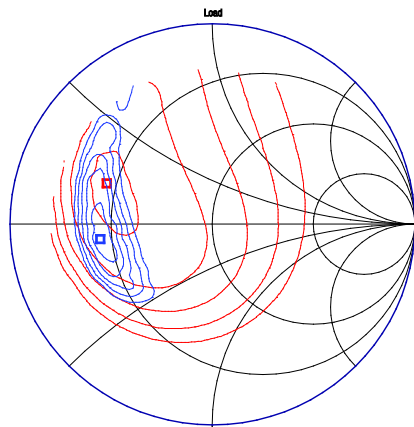

Figure 19. OIP3 Load Pull @ 0.75 GHz, 5 V, 76 mA
 (Input Load = NF Min., -20 dBm/Tone, 5 MHz Spacing)

Table 4. Noise Parameters vs Frequency @ 25 °C, 5 V, 76 mA (1 of 2)

Frequency (GHz)	Minimum Noise Figure (F _{MIN}) (dB)	Noise Resistance (R _N) (Ω)	Γ _{opt}		Associated Gain (dB)	Maximum Gain (G _{MAX}) (dB)
			Magnitude	Phase		
0.35	0.4326	0.0000	0.1806	69.36	23.4394	23.82222468
0.40	0.4819	0.0100	0.1797	70.08	22.3696	22.68049256
0.45	0.5265	0.0300	0.1796	70.95	21.3451	21.59645184
0.50	0.5671	0.0473	0.1800	71.94	20.3647	20.56825726
0.55	0.6042	0.0622	0.1810	73.05	19.4273	19.59406356
0.60	0.6385	0.0749	0.1827	74.28	18.5316	18.67202547
0.65	0.6707	0.0857	0.1848	75.60	17.6766	17.80029773
0.70	0.7014	0.0949	0.1875	77.01	16.8610	16.97703507
0.75	0.7313	0.1026	0.1906	78.51	16.0838	16.20039224
0.80	0.7610	0.1092	0.1942	80.09	15.3437	15.46852398
0.85	0.7912	0.1150	0.1983	81.73	14.6396	14.77958501
0.90	0.8224	0.1202	0.2027	83.42	13.9704	14.13173007
0.95	0.8555	0.1251	0.2076	85.17	13.3349	13.52311391
1.00	0.8909	0.1298	0.2128	86.95	12.7320	12.95189125
1.05	0.9294	0.1348	0.2183	88.76	12.1604	12.41621685
1.10	0.9716	0.1402	0.2242	90.60	11.6190	11.91424542
1.15	1.0181	0.1464	0.2303	92.44	11.1068	11.44413172
1.20	1.0697	0.1535	0.2367	94.29	10.6224	11.00403047
1.25	1.1269	0.1619	0.2433	96.14	10.1648	10.59209642
1.30	1.1904	0.1718	0.2501	97.97	9.7328	10.2064843
1.35	1.2608	0.1835	0.2571	99.78	9.3253	9.845348845
1.40	1.3388	0.1972	0.2643	101.55	8.9410	9.506844798
1.45	1.4251	0.2133	0.2716	103.29	8.5789	9.189126894
1.50	1.5203	0.2319	0.2790	104.97	8.2378	8.890349869
1.55	1.6250	0.2533	0.2864	106.60	7.9165	8.608668461
1.60	1.7399	0.2778	0.2939	108.16	7.6139	8.342237407
1.65	1.8657	0.3057	0.3015	109.64	7.3288	8.089211444
1.70	2.0029	0.3371	0.3090	111.03	7.0601	7.847745308
1.75	2.1522	0.3725	0.3165	112.34	6.8066	7.615993738
1.80	2.3144	0.4120	0.3240	113.54	6.5671	7.392111469
1.85	2.4900	0.4560	0.3314	114.62	6.3405	7.174253239
1.90	2.6796	0.5046	0.3386	115.59	6.1256	6.960573785
1.95	2.8840	0.5581	0.3458	116.43	5.9213	6.749227845
2.00	3.1038	0.6168	0.3528	117.12	5.7265	6.538370154

Table 4. Noise Parameters vs Frequency @ 25 °C (2 of 2)

Frequency (GHz)	Minimum Noise Figure (F _{MIN}) (dB)	Noise Resistance (R _N) (Ω)	Γ _{opt}		Associated Gain (dB)	Maximum Gain (G _{MAX}) (dB)
			Magnitude	Phase		
2.05	3.3396	0.6810	0.3596	117.67	5.5399	6.32615545
2.10	3.5920	0.7510	0.3662	118.07	5.3604	6.110738471
2.15	3.8618	0.8269	0.3725	118.30	5.1869	5.890273953
2.20	4.1496	0.9091	0.3786	118.35	5.0182	5.662916633
2.25	4.4559	0.9978	0.3844	118.22	4.8532	5.426821248
2.30	4.7816	1.0932	0.3899	117.90	4.6906	5.180142536
2.35	5.1272	1.1958	0.3951	117.38	4.5293	4.921035233
2.40	5.4933	1.3056	0.3999	116.64	4.3683	4.647654076
2.45	5.8806	1.4230	0.4043	115.69	4.2063	4.358153803
2.50	6.2898	1.5482	0.4083	114.52	4.0421	4.050689151

Evaluation Board Description

The SKY67110-396LF Evaluation Board is used to test the performance of the SKY67110-396LF LNA. An assembly drawing for the Evaluation Board is shown in Figure 20. An Evaluation Board schematic diagram is provided in Figure 21. Table 5 provides the Bill of Materials (BOM) list for Evaluation Board components.

The test board uses a 10 mil Rogers 4350B substrate on a 50 mil FR4 supporting substrate. The Rogers 4350B material was selected for the RF circuit because of its low dielectric constant (ε_r) and low ε_r variation over temperature for the best possible noise performance.

Package Dimensions

The PCB layout footprint for the SKY67110-396LF is provided in Figure 22. Typical case markings are shown in Figure 23. Package dimensions for the 8-pin DFN are shown in Figure 24, and tape and reel dimensions are provided in Figure 25.

Package and Handling Information

Instructions on the shipping container label regarding exposure to moisture after the container seal is broken must be followed. Otherwise, problems related to moisture absorption may occur when the part is subjected to high temperature during solder assembly.

THE SKY67110-396LF is rated to Moisture Sensitivity Level 1 (MSL1) at 260 °C. It can be used for lead or lead-free soldering. For additional information, refer to the Skyworks Application Note, *Solder Reflow Information*, document number 200164.

Care must be taken when attaching this product, whether it is done manually or in a production solder reflow environment. Production quantities of this product are shipped in a standard tape and reel format.

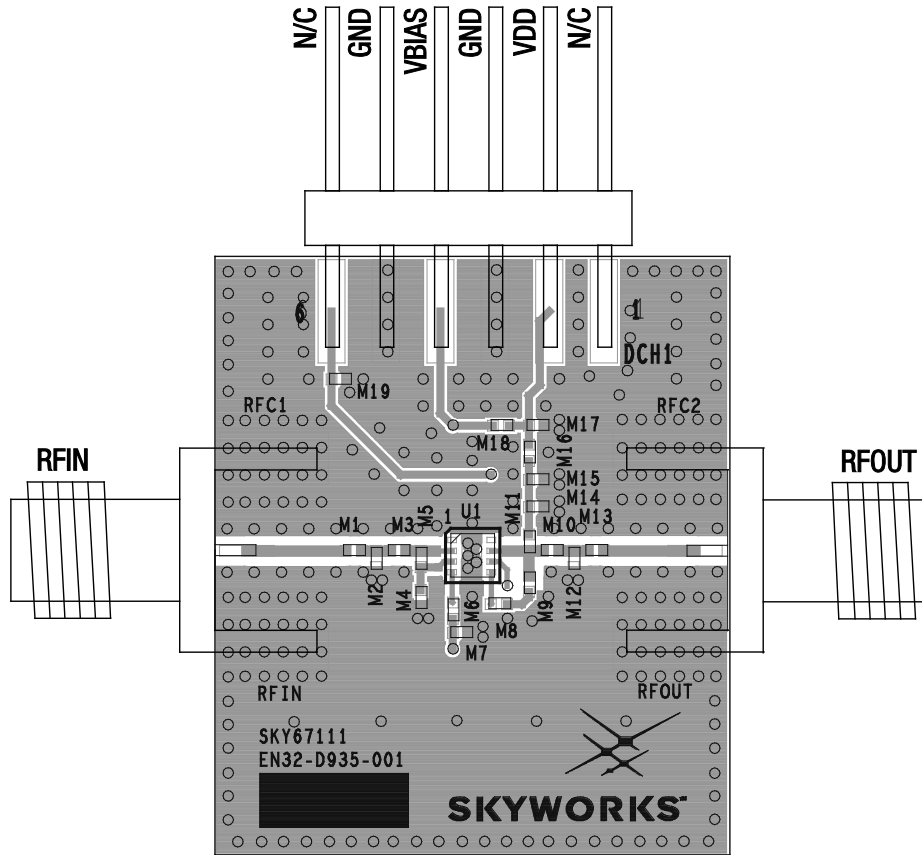
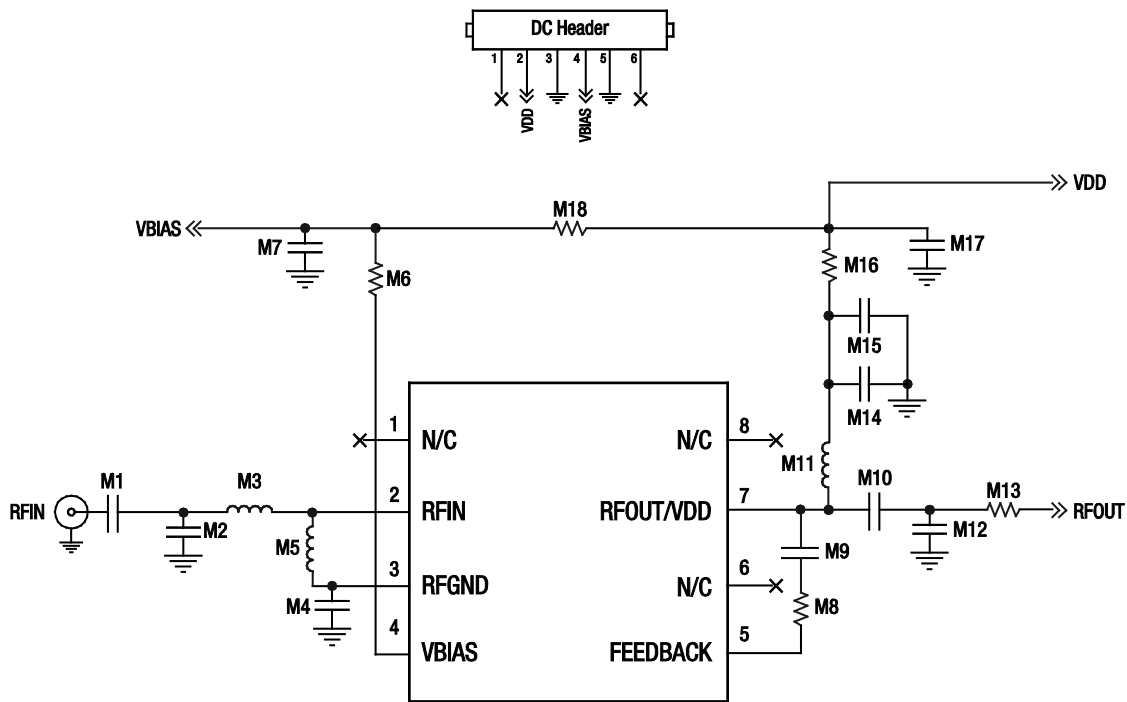

Figure 20. SKY67110-396LF Evaluation Board Assembly Diagram



Note: Some component symbols may indicate a different component than what is reported in the BOM (see Table 4). Component values noted in the BOM, however, are accurate as of the date of this Data Sheet.

S2832

Figure 21. SKY67110-396LF Evaluation Board Schematic

Table 5. SKY67110-396LF Evaluation Board Bill of Materials

Component	Value	Size	Manufacturer	Part #	Comments
M1	9 pF	0402	Murata	GJM1555C1H9R0DB01	Capacitor
M2, M8, M9, M19	DNI	-	-	-	-
M3	1 nH	0402	Coilcraft	0402HP-1N0XJL	Inductor
M4	82 pF	0402	Murata	GRM1555C1H820JZ01	Capacitor
M5	22 nH	0402	Coilcraft	0402HP-22NX_L	Inductor
M6	7500 Ω	0402	Panasonic	ERJ-2GEJ752X	Resistor
M7, M15, M17	1000 pF	0402	Murata	GRM155R71H102KA01	Capacitor
M10	8.2 pF	0402	Murata	GRM1555C1H8R2DZ01	Capacitor
M11	12 nH	0402	Murata	LQG15HS12NJ02	Inductor
M12	22 nH	0402	TDK	MLG1005S22NJ	Inductor
M13	120 pF	0402	Murata	GRM1555C1H121JA01	Capacitor
M14	2.2 pF	0402	Murata	GRM1555C1H2R2CZ01	Capacitor
M16, M18	0 Ω	0402	Panasonic	ERJ2GE0R00X	Resistor

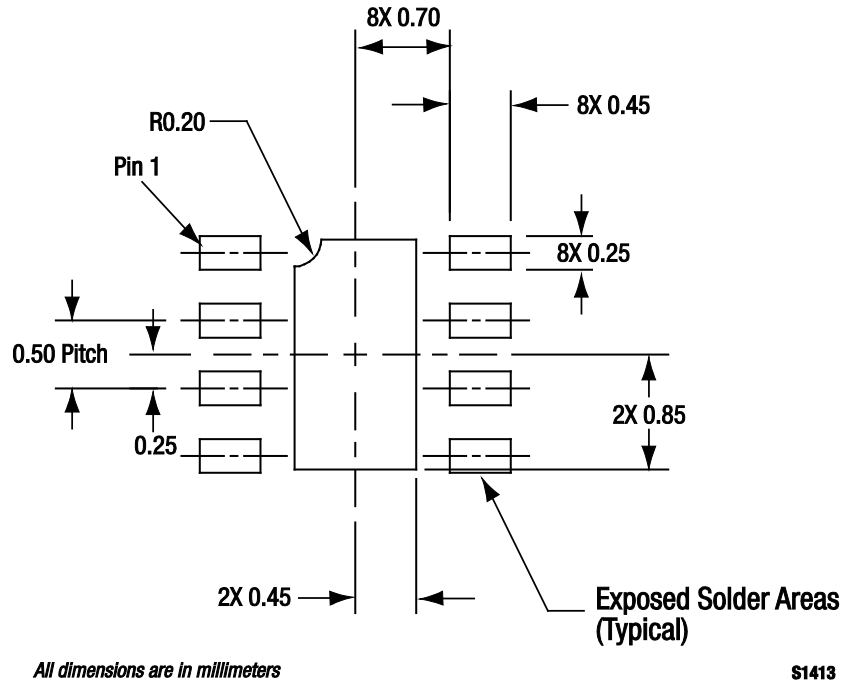

Figure 22. SKY67110-396LF PCB Layout Footprint (Top View)

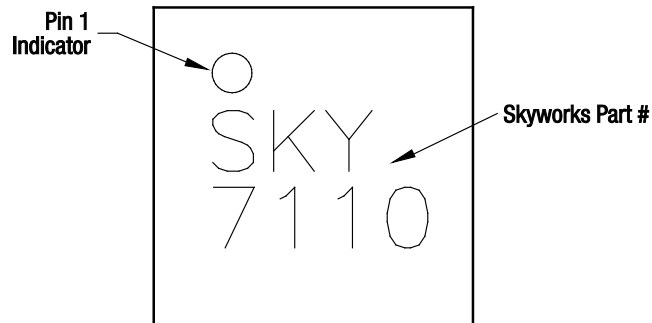
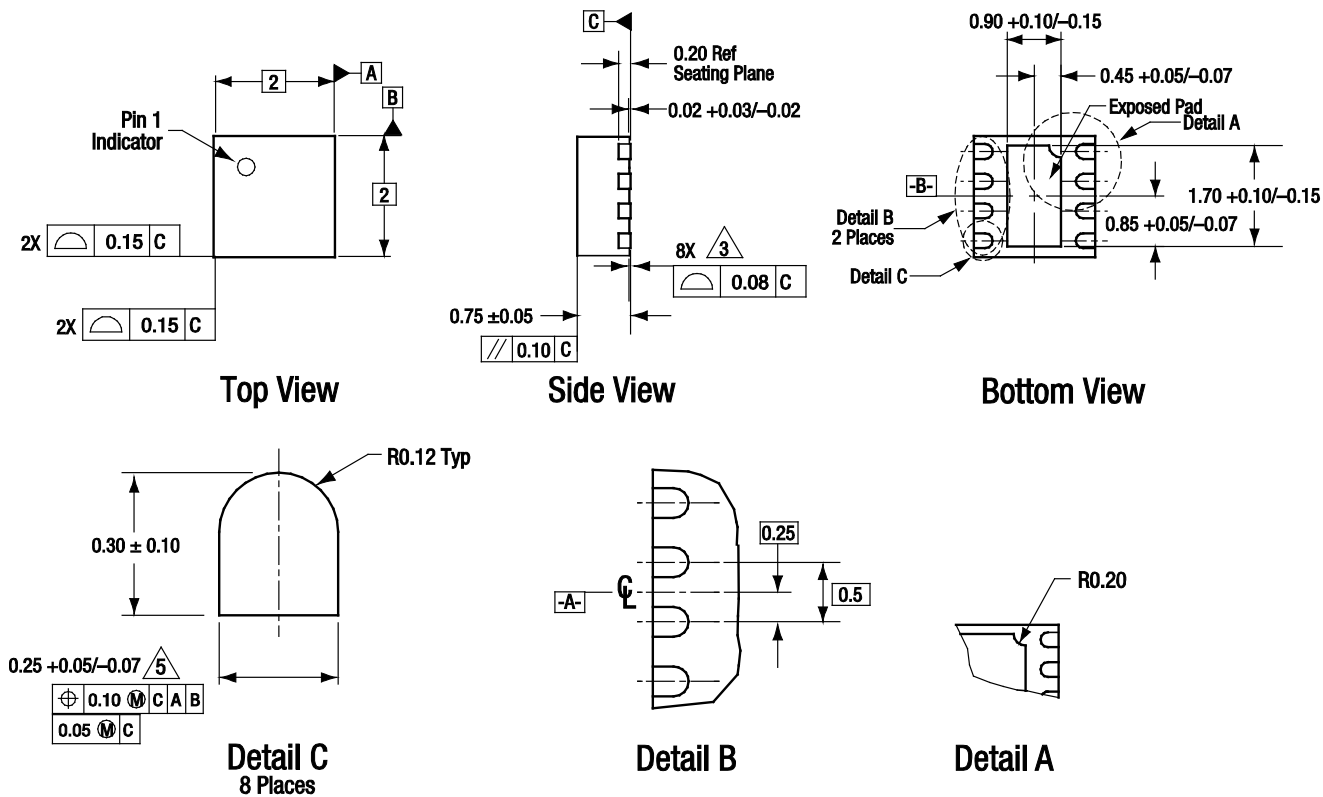

Figure 23. Typical Case Markings (Top View)



All measurements are in millimeters.
 Dimensioning and tolerancing according to ASME Y14.5M-1994.
 Coplanarity applies to the exposed heat sink slug as well as the terminals.
 Plating requirement per source control drawing (SCD) 2504.
 Dimension applies to metallized terminal and is measured between 0.15 mm and 0.30 mm from terminal tip.

S1945

Figure 24. SKY67110-396LF 8-Pin DFN Package Dimensions

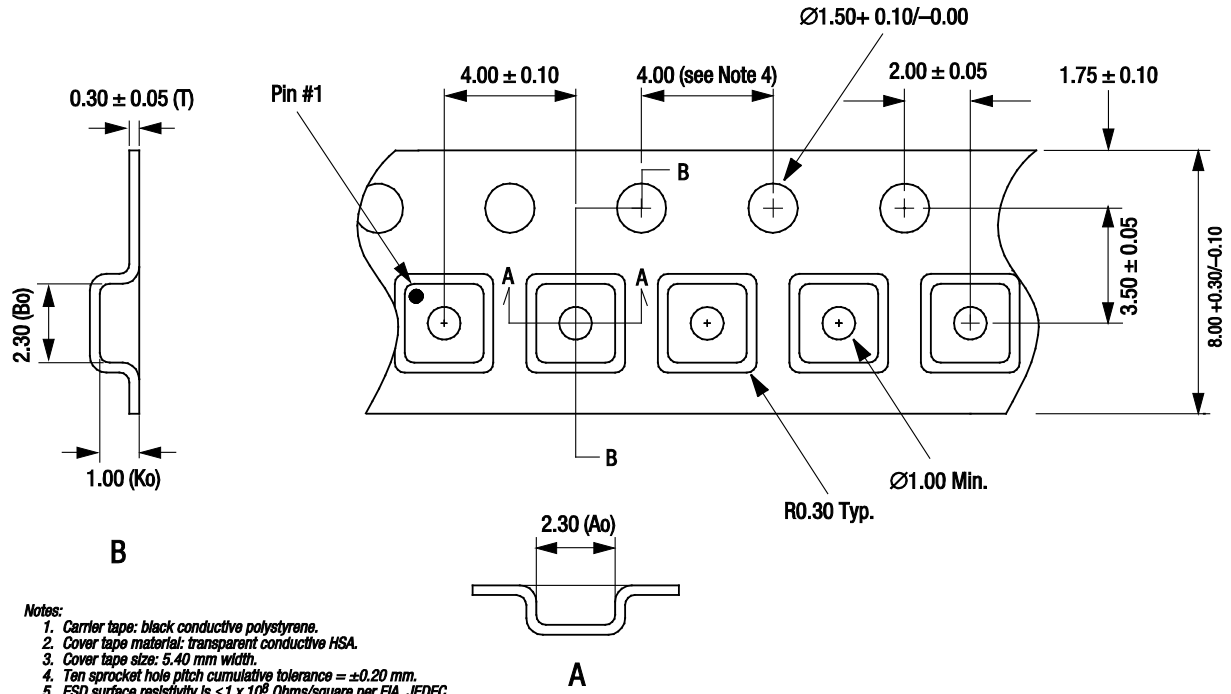

S1601

Figure 25. SKY67110-396LF Tape and Reel Dimensions

Ordering Information

Model Name	Manufacturing Part Number	Evaluation Board Part Number
SKY67110-396LF LNA	SKY67110-396LF	SKY67110-396LF-EVB

Copyright © 2012, 2013 Skyworks Solutions, Inc. All Rights Reserved.

Information in this document is provided in connection with Skyworks Solutions, Inc. ("Skyworks") products or services. These materials, including the information contained herein, are provided by Skyworks as a service to its customers and may be used for informational purposes only by the customer. Skyworks assumes no responsibility for errors or omissions in these materials or the information contained herein. Skyworks may change its documentation, products, services, specifications or product descriptions at any time, without notice. Skyworks makes no commitment to update the materials or information and shall have no responsibility whatsoever for conflicts, incompatibilities, or other difficulties arising from any future changes.

No license, whether express, implied, by estoppel or otherwise, is granted to any intellectual property rights by this document. Skyworks assumes no liability for any materials, products or information provided hereunder, including the sale, distribution, reproduction or use of Skyworks products, information or materials, except as may be provided in Skyworks Terms and Conditions of Sale.

THE MATERIALS, PRODUCTS AND INFORMATION ARE PROVIDED "AS IS" WITHOUT WARRANTY OF ANY KIND, WHETHER EXPRESS, IMPLIED, STATUTORY, OR OTHERWISE, INCLUDING FITNESS FOR A PARTICULAR PURPOSE OR USE, MERCHANTABILITY, PERFORMANCE, QUALITY OR NON-INFRINGEMENT OF ANY INTELLECTUAL PROPERTY RIGHT; ALL SUCH WARRANTIES ARE HEREBY EXPRESSLY DISCLAIMED. SKYWORKS DOES NOT WARRANT THE ACCURACY OR COMPLETENESS OF THE INFORMATION, TEXT, GRAPHICS OR OTHER ITEMS CONTAINED WITHIN THESE MATERIALS. SKYWORKS SHALL NOT BE LIABLE FOR ANY DAMAGES, INCLUDING BUT NOT LIMITED TO ANY SPECIAL, INDIRECT, INCIDENTAL, STATUTORY, OR CONSEQUENTIAL DAMAGES, INCLUDING WITHOUT LIMITATION, LOST REVENUES OR LOST PROFITS THAT MAY RESULT FROM THE USE OF THE MATERIALS OR INFORMATION, WHETHER OR NOT THE RECIPIENT OF MATERIALS HAS BEEN ADVISED OF THE POSSIBILITY OF SUCH DAMAGE.

Skyworks products are not intended for use in medical, lifesaving or life-sustaining applications, or other equipment in which the failure of the Skyworks products could lead to personal injury, death, physical or environmental damage. Skyworks customers using or selling Skyworks products for use in such applications do so at their own risk and agree to fully indemnify Skyworks for any damages resulting from such improper use or sale.

Customers are responsible for their products and applications using Skyworks products, which may deviate from published specifications as a result of design defects, errors, or operation of products outside of published parameters or design specifications. Customers should include design and operating safeguards to minimize these and other risks. Skyworks assumes no liability for applications assistance, customer product design, or damage to any equipment resulting from the use of Skyworks products outside of stated published specifications or parameters.

Skyworks, the Skyworks symbol, and "Breakthrough Simplicity" are trademarks or registered trademarks of Skyworks Solutions, Inc., in the United States and other countries. Third-party brands and names are for identification purposes only, and are the property of their respective owners. Additional information, including relevant terms and conditions, posted at www.skyworksinc.com, are incorporated by reference.