

SUMMARY

Wires

Low	4
High	0
Coax	0
Triax	0
Quad	0
Fiber	0
Fluidic	0

Series	2B
Termination type	Male solder
IP rating	50
Cable Ø	5.30 - 6.20 mm
Matching parts	EGG.2B.304.CLL
Status	
Alternative part	



Image is for illustrative purpose only

Download

[Request a quote](#)

[Catalog](#)

TECHNICAL DETAILS

Mechanics

Shell Style/Model	FG*: Straight plug, cable collet
Keying	1 key (alpha=0, plug: male contacts, receptacle: female contacts)
Housing Material	Brass (chrome plated) shell and collet nut, nickel plated brass latch sleeve and mid pieces
Cable Fixing	D62: 5.3 - 6.2 mm
Variant	

Performance

Configuration	2B.304 : 4 Low Voltage
Insulator	L: PEEK (UL 94 / V-0/3.2, depends on material thickness)
Rated Current	15 Amps

Specifications

Contact Type:	Solder
Max. Matings:	5000
Contact Dia.:	1.3 mm (0.051in)
Bucket Dia.:	1 mm (0.039in)
Max. Solid Conductor:	0.5 mm ² (AWG 20)
Max. Stranded Conductor:	0.5 mm ² (AWG 20)

R (max): 3.6 mOhm
Vtest (contact-shell): 1850 V (AC), 2600 V (DC)
Vtest (contact-contact): 1850 V (AC), 2600 V (DC)

Others

Temp (min / max): -55°C / +250°C
Humidity (max): <=95% [at 60 deg C / 140 F]
Vibration: 15 g [10 Hz - 2000 Hz]
Shock Resistance: 100 g [6 ms]
Salt Spray Corrosion: >1000 hr
Climatical Category: 50/175/21
Shielding (min): 75 dB (10 MHz)
Shielding (min): 40 dB (1 GHz)
IP Rating: 50

DRAWINGS

Draws

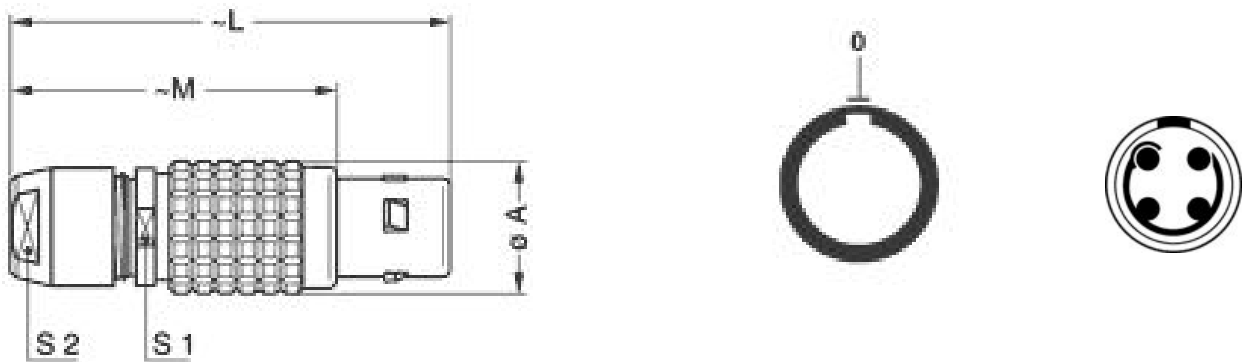

Dimensions







	A	L	M	S1	S2
mm.	15	50	38	13	12
in.	0,59	1,97	1,50	0,51	0,47

RECOMMENDED BY LEMO

Tools

Spanner wrench: MTZ.2B.220.120
Caps: BFG.2B.100.PCSG

Cables

CMN.04.T20.053PGCE	PVC	GREY	
CMN.04.T20.053PGZE		Grey	
CMN.04.T20.053PNCE	PVC	Black	
CMN.04.T20.053PNZE			
CMN.04.T20.053QGZE	TPR (medical)	Grey	
004 220	PVC	Black	
104 200	PVC	Black	
240 500	PVC	Grey	