

REVISIONS					
REV	ECO	DESCRIPTION	DATE	BY	APPR
A1	-	FIRST RELEASE	Sep.07,2015	Drack	Tommy

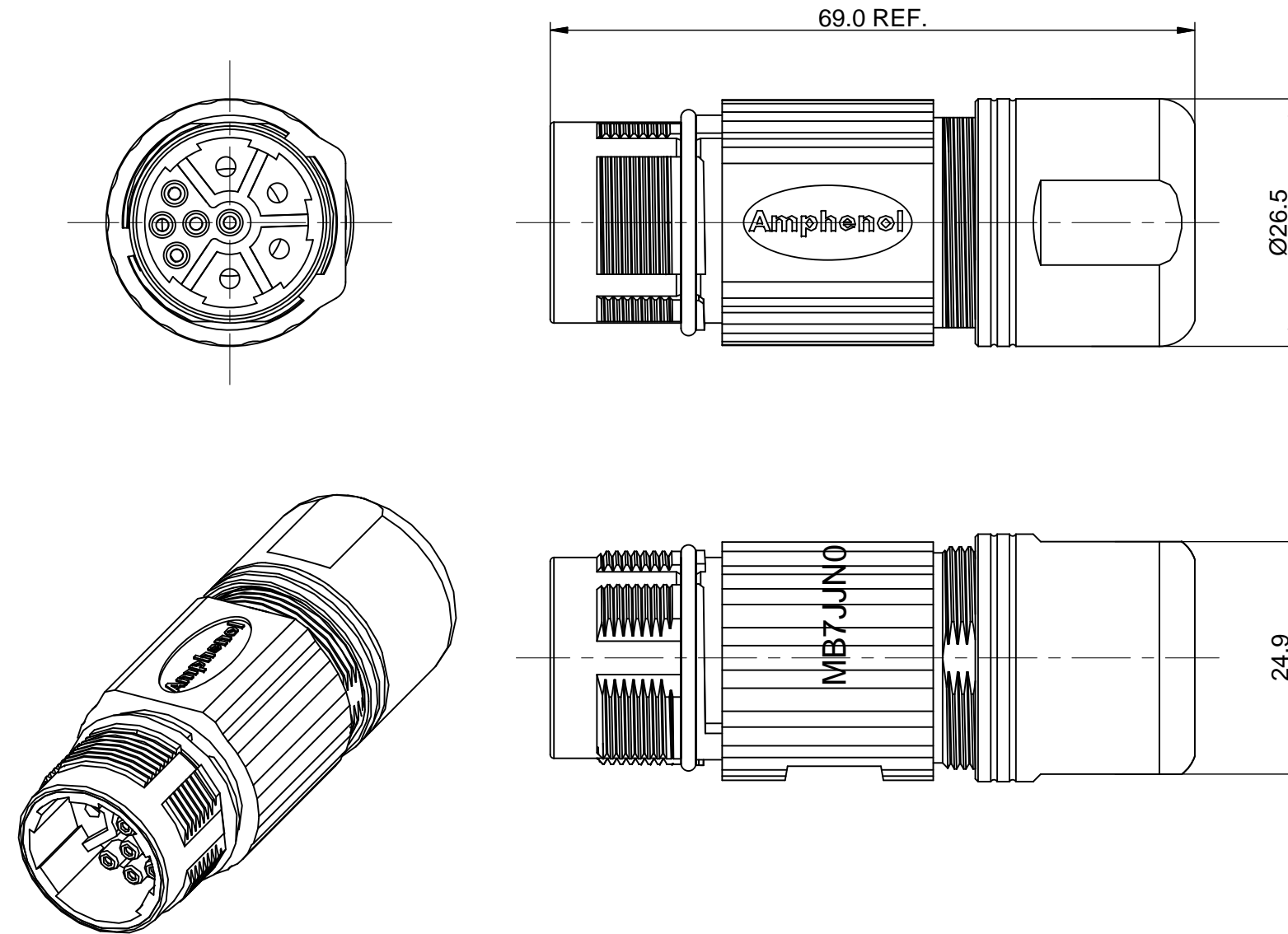

NOTES: UNLESS OTHERWISE SPECIFIED

- MATERIAL:
INSULATION INSERT: PA66, UL94 V0
SEAL: VITON, SILICONE, EPDM
HOUSING BODY: ZINC DIE CAST, NICKEL PLATED
- SPECIFICATIONS:
 - CURRENT RATING: SIGNAL: 10 AMPS
POWER: 30 AMPS
 - VOLTAGE RATING: SIGNAL: 250V AC/DC
POWER: 630V AC/DC
 - OPERATING TEMPERATURE: -20°C TO +130°C
 - DIELECTRIC WITHSTANDING VOLTAGE: LESS THAN 2 MILLIAMPS CURRENT LEAKAGE @ SIGNAL: 2500VOLTS AC.
POWER: 6000 VOLTS AC.
 - DEGREE OF PROTECTION: IP67 (MATED CONDITION)
 - DEGREE OF POLLUTION: 3 PER UL840
 - OVERVOLTAGE CATEGORY: III PER UL840
 - MATING CYCLE DURABILITY: >500 CYCLES
 - RoHS COMPLIANT
- ALL DIMENSIONS ARE FOR REFERENCE USE ONLY.

Item	Part number	Cable OD Range
1	MB7JJN0900-S1	7.5~11.0 mm
2	MB7JJN0900-S2	11.0~14.5 mm
3	MB7JJN0900-S3	14.5~17.0 mm

QUANTITY	SEE PART NUMBER CHART PART NUMBER	DESCRIPTION	ITEM								
MATERIALS LIST											
UNLESS OTHERWISE SPECIFIED 1) All dimensions are in metric (mm). 2) Tolerances are as follows: 1 PL DEC ±0.30 2 PL DEC ±0.15 3 PL DEC ±0.08 Fractions ±1/64 Angles ±1° 3) Note reference =		SIGNATURES DRAWN: Drack CHECKED: ENGINEER: APPROVAL:	DATE Sep.07,2015								
MATERIAL SPECIFICATIONS:		<div style="text-align: center;"> <h1>Amphenol</h1> <p>Sine Systems - www.amphenol-sine.com 44724 Morley Drive Clinton Township, MI 48036</p> <p>M23B, RECEPTACLE, STR, 9POS(5+4)</p> </div>									
PROCESS SPECIFICATIONS:											
NEXT ASSY:		CUSTOMER: THIS DRAWING IS SUPPLIED FOR INFORMATION ONLY. DESIGN FEATURES, SPECIFICATIONS AND PERFORMANCE DATA SHOWN HEREON ARE THE PROPERTY OF THE AMPHENOL CORPORATION. NO RIGHTS OF REPRODUCTION ARE IMPLIED. ALL DIMENSIONS ARE SUBJECT TO NORMAL MANUFACTURING VARIATIONS.	<table border="1"> <tr> <td>SIZE</td> <td>TYPE</td> <td>DWG NO.</td> <td>REVISION</td> </tr> <tr> <td>B</td> <td>C-</td> <td>MB7JJN0900-Sx</td> <td>A1</td> </tr> </table>	SIZE	TYPE	DWG NO.	REVISION	B	C-	MB7JJN0900-Sx	A1
SIZE	TYPE	DWG NO.	REVISION								
B	C-	MB7JJN0900-Sx	A1								
		SCALE: NONE	SHEET 1 OF 1								

TITLE: M23B, RECEPTACLE, STR, 9POS(5+4) DWG NO: MB7JJN0900-Sx REV: A1 SH: 1 OF: 1