

SPECIFICATION

PATENT GRANTED

Part No : **FXUB66.07.0150C**

Product Name : Maximus
Flexible Ultra Wide Band Antenna 700-6000MHz

Features : Ground Plane Independent
700-6000MHz
5 dBi Peak Gain
Efficiencies above 60% on all cellular 4G/3G/2G bands
120.4x50.4x0.2 mm size
IPEX MHF (U.FL Compatible) Connector

RoHS Compliant



1. Introduction

The patent pending Maximus FXUB66 flexible ultra wideband antenna has been designed to cover all working frequencies in the 700-6000 MHz spectrum, including all Cellular, Wi-Fi, ISM and GNSS bands. Its use in a device improves substantially the radiated power and sensitivity, and enables the highest throughput rates of today's broadband devices.

The antenna is delivered with a flexible body with ground breaking high efficiencies on all bands, ground-plane independent, with a cable and connector for easy installation. It is made of durable flexible polymer, with a peak gain of 5dBi, an efficiency of more than 60% across all cellular bands and is designed to be mounted directly onto a plastic or glass enclosure / cover.

At 120.4x50.4x.2mm, the antenna is ultra thin. It is assembled by a simple "peel and stick" process, attaching securely to non-metal surfaces via 3M adhesive. It enables designers to use only one antenna that covers all frequencies and future proofs device design for LTE and 4G globally. It is also the ideal antenna to fit in devices that are being retrofitted with wireless functionality, as it will cover non cellular applications such as 868, 915MHz or Zigbee applications. It's inherently wide bandwidth is more resistant to detuning than traditional small but narrow-band legacy antennas.

The Maximus antenna has a unique hybrid design. Within one antenna structure the electromagnetic waves travel in two predominant propagation modes - one for lower frequencies, (e.g. LTE at 700 MHz) and the other for higher 4G and Wi-Fi frequencies up to 6GHz.

It is an ideal choice for any device maker that needs to keep manufacturing costs down over the lifetime of a product, as the same antenna can be used if the radio module is upgraded to work on a different frequency band.

Cables and Connectors are customizable.

2. Specification

ELECTRICAL									
Band	700/850/900	1400	1575	1700/1800/1900	2100	2400	2600	3500	5000
Standard	LTE/GSM/CDMA	MIL	GPS	LTE/GSM/CDMA	UMTS/HSPA	ISM/WIFI	LTE	LTE	ISM/WIFI
Frequency	698-960 MHz	1390-1435 MHz	1575.42 MHz	1710-1990 MHz	1755-2170 MHz	2400-2500 MHz	2500-2700 MHz	3400-3600 MHz	4800-6000 MHz
Polarization	Linear								
Impedance	50 Ohms								
Max VSWR	3.5:1	3.5:1	1.1:1	3.0:1	3.3:1	2.2:1	2.0:1	2.2:1	3.0:1
Max Return Loss	-5dB	-5dB	-20dB	-6dB	-5.5dB	-7dB	-10dB	-7dB	-6dB
Peak Gain	2.7dBi	3.8dBi	5dBi	5dBi	5dBi	3.5dBi	3.8dBi	6.4dBi	5.5dBi
Efficiency	80%	55%	75%	78%	65%	75%	75%	85%	60%
Average Gain	-0.97dB	-2.6dB	-1.1dB	-1dB	-1.8dB	-1.1dB	-1.1dB	-0.7dB	-2dB
Radiation Properties	Omni-directional								
Max Input Power	5W								

*Antenna measured on 2mm ABS plastic plate.

MECHANICAL

Dimensions (mm)	120.4x50.4x0.2 mm
Material	Flexible Polymer
Connector and Cable	U.FL and 1.37 mm mini coax

ENVIRONMENTAL

Operation Temperature	-40°C to 85°C
Storage Temperature	-40°C to 85°C
Relative Humidity	40% to 95%
RoHs Compliant	Yes

LTE BANDS			
Band Number	LTE / LTE-Advanced / WCDMA / HSPA / HSPA+ / TD-SCDMA		
	Uplink	Downlink	Covered
1	UL: 1920 to 1980	DL: 2110 to 2170	✓
2	UL: 1850 to 1910	DL: 1930 to 1990	✓
3	UL: 1710 to 1785	DL: 1805 to 1880	✓
4	UL: 1710 to 1755	DL: 2110 to 2155	✓
5	UL: 824 to 849	DL: 869 to 894	✓
7	UL: 2500 to 2570	DL: 2620 to 2690	✓
8	UL: 880 to 915	DL: 925 to 960	✓
9	UL: 1749.9 to 1784.9	DL: 1844.9 to 1879.9	✓
11	UL: 1427.9 to 1447.9	DL: 1475.9 to 1495.9	✓
12	UL: 699 to 716	DL: 729 to 746	✓
13	UL: 777 to 787	DL: 746 to 756	✓
14	UL: 788 to 798	DL: 758 to 768	✓
17	UL: 704 to 716	DL: 734 to 746 (LTE only)	✓
18	UL: 815 to 830	DL: 860 to 875 (LTE only)	✓
19	UL: 830 to 845	DL: 875 to 890	✓
20	UL: 832 to 862	DL: 791 to 821	✓
21	UL: 1447.9 to 1462.9	DL: 1495.9 to 1510.9	✓
22	UL: 3410 to 3490	DL: 3510 to 3590	✓
23	UL: 2000 to 2020	DL: 2180 to 2200 (LTE only)	✓
24	UL: 1625.5 to 1660.5	DL: 1525 to 1559 (LTE only)	✓
25	UL: 1850 to 1915	DL: 1930 to 1995	✓
26	UL: 814 to 849	DL: 859 to 894	✓
27	UL: 807 to 824	DL: 852 to 869 (LTE only)	✓
28	UL: 703 to 748	DL: 758 to 803 (LTE only)	✓
29	UL: -	DL: 717 to 728 (LTE only)	✓
30	UL: 2305 to 2315	DL: 2350 to 2360 (LTE only)	✓
31	UL: 452.5 to 457.5	DL: 462.5 to 467.5 (LTE only)	✗
32	UL: -	DL: 1452 - 1496	✓
35		1850 to 1910	✓
38		2570 to 2620	✓
39		1880 to 1920	✓
40		2300 to 2400	✓
41		2496 to 2690	✓
42		3400 to 3600	✓
43		3600 to 3800	✓

*Covered bands represent an efficiency greater than 20%

3. Test Setup



Figure 1. Impedance measurements (left hand) and peak gain, average gain, efficiency and radiation pattern measurements (right hand).

4. Antenna Parameters

4.1. Return Loss

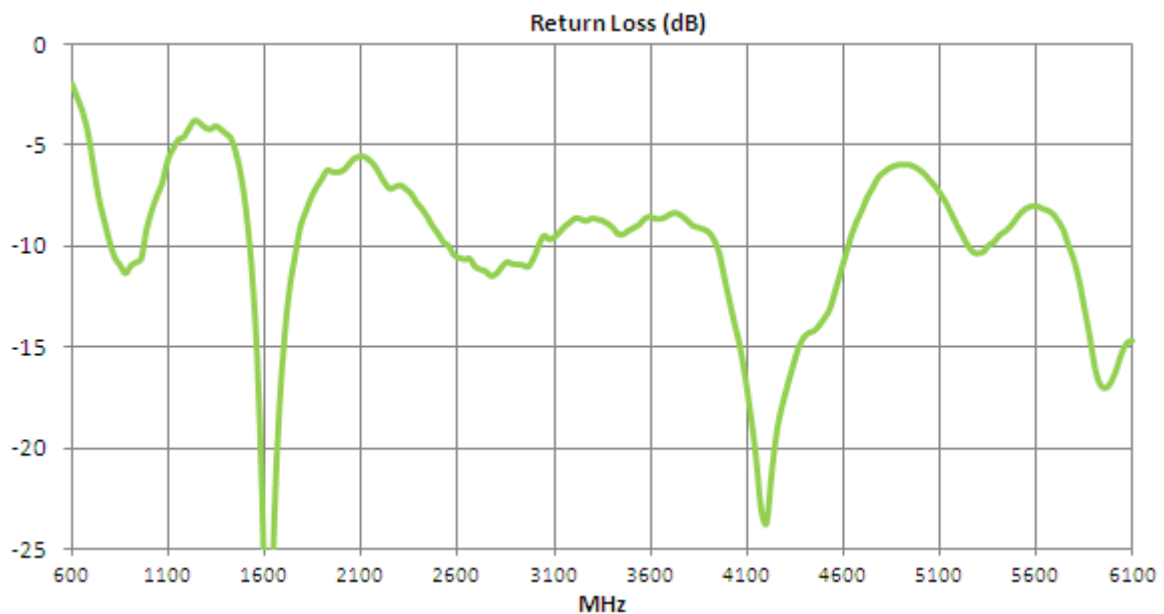

Figure 2. Return loss of FXUB66 UWB Antenna.

4.2. VSWR

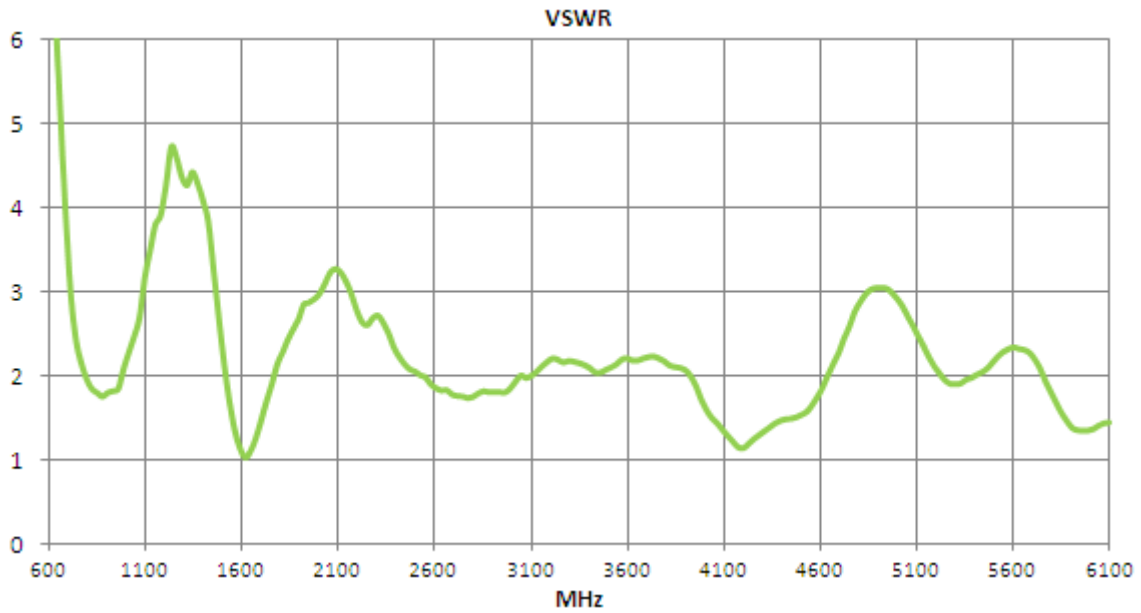

Figure 3. VSWR of FXUB66 UWB Antenna.

4.3. Efficiency

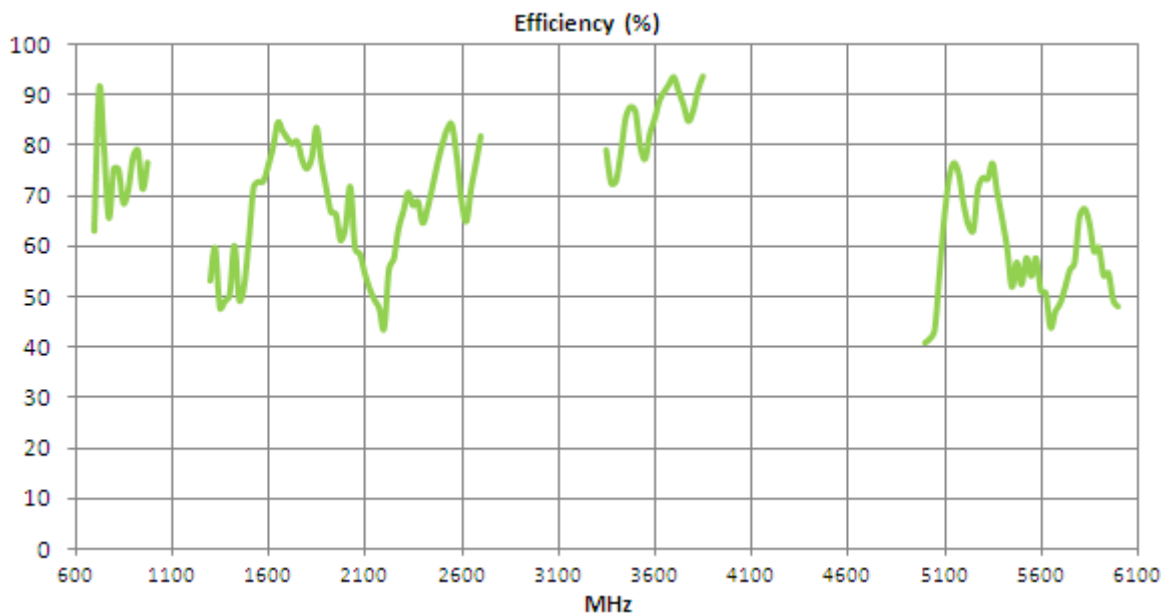

Figure 4. Efficiency of FXUB66 UWB Antenna.

4.4. Peak Gain

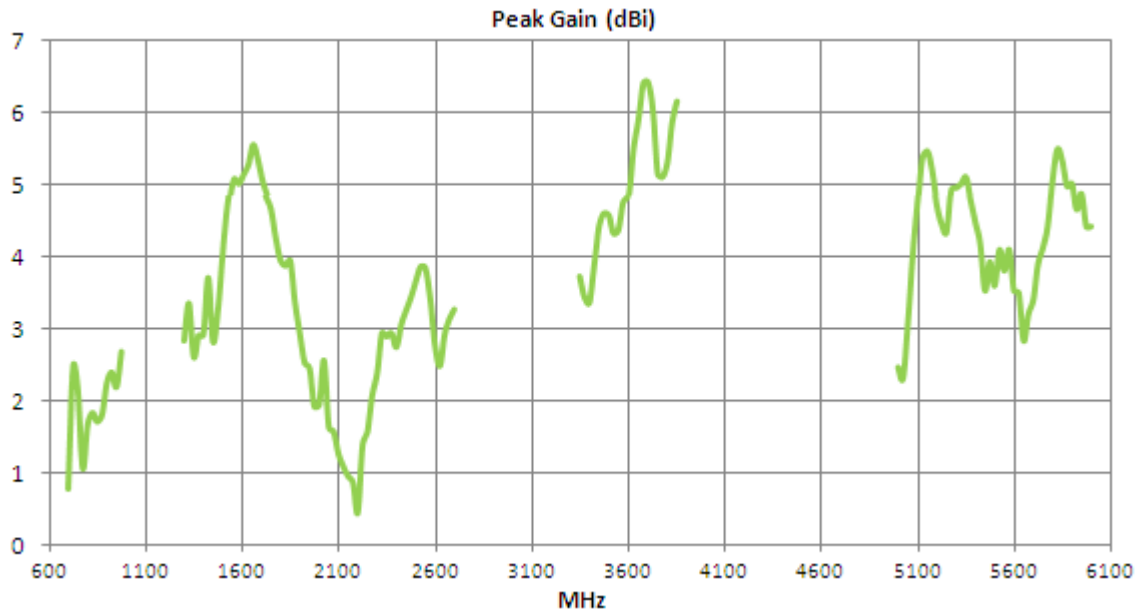

Figure 5. Peak Gain of FXUB66 UWB Antenna.

4.5. Average Gain

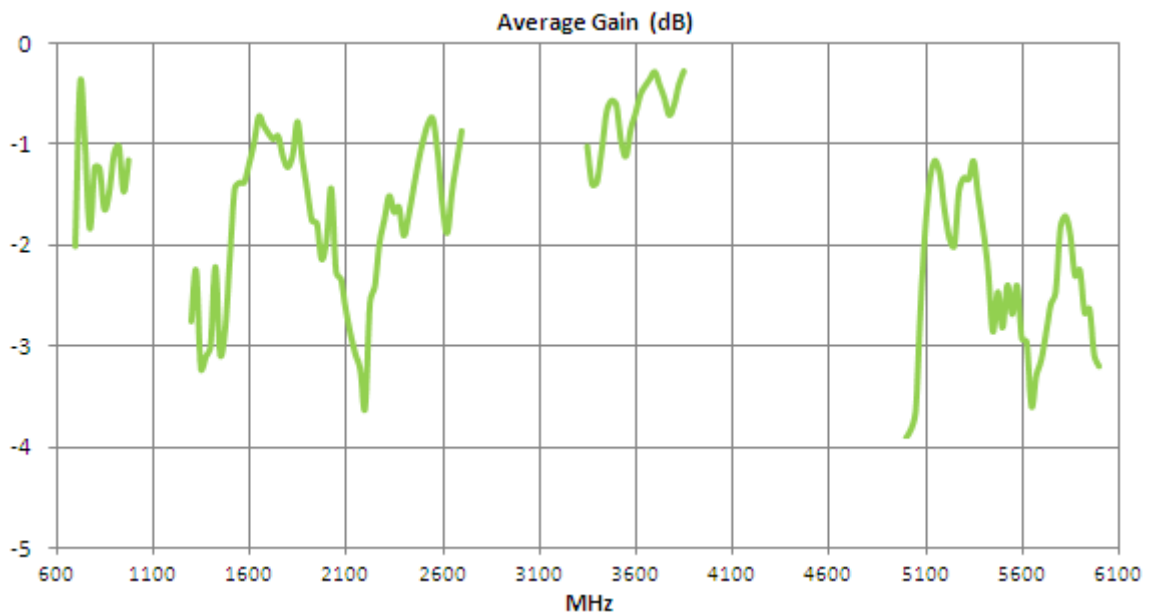

Figure 6. Average Gain of FXUB66 UWB Antenna.

4.6. Radiation Pattern

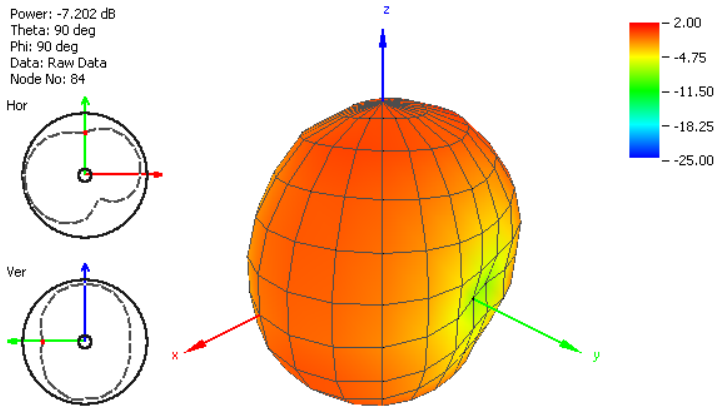

Figure 7. Radiation Pattern at 750 MHz of FXUB66 UWB Antenna.

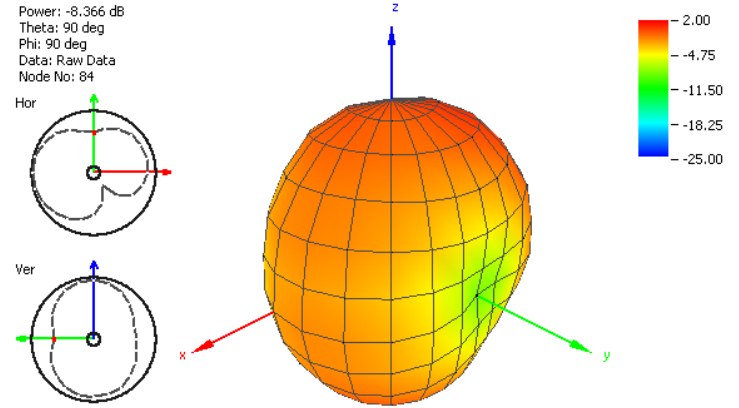

Figure 8. Radiation Pattern at 850 MHz of FXUB66 UWB Antenna.

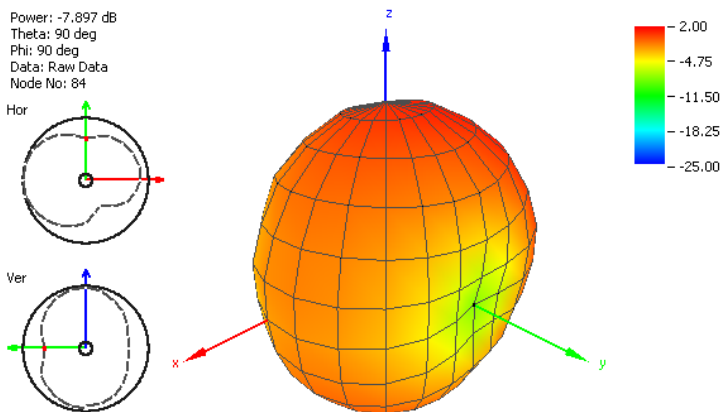

Figure 9. Radiation Pattern at 925 MHz of FXUB66 UWB Antenna.

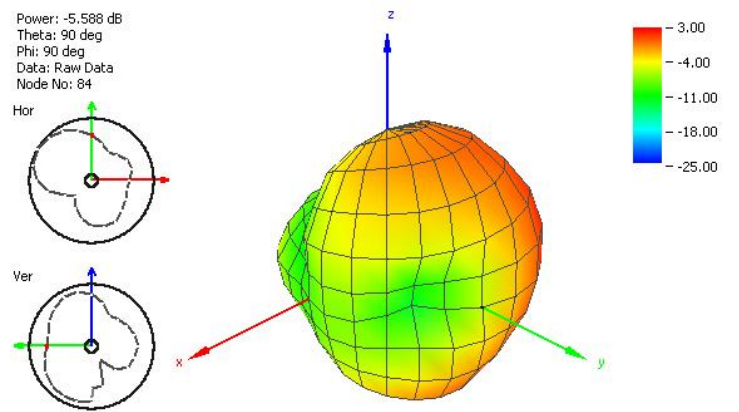

Figure 10. Radiation Pattern at 1400 MHz of FXUB66 UWB Antenna.

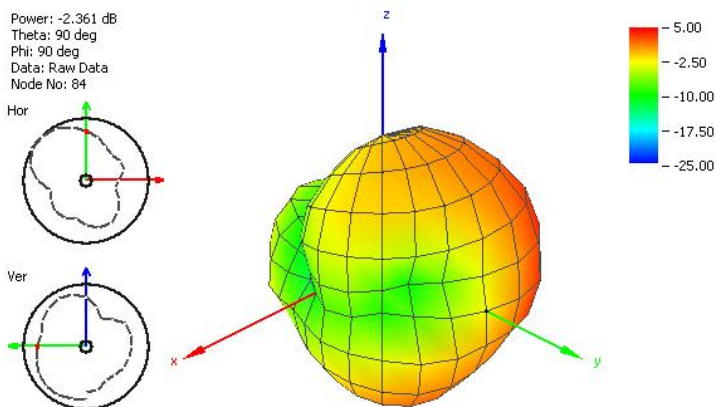

Figure 11. Radiation Pattern at 1575 MHz of FXUB66 UWB Antenna.

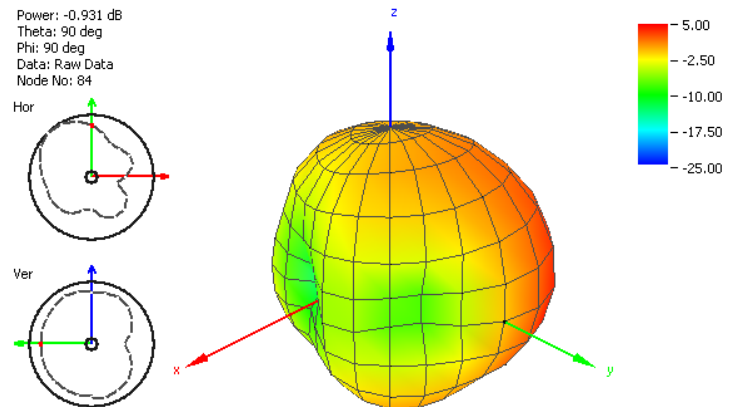

Figure 12. Radiation Pattern at 1750 MHz of FXUB66 UWB Antenna.

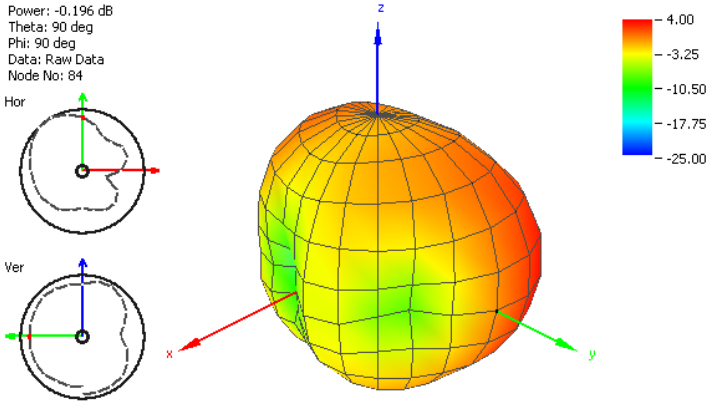

Figure 13. Radiation Pattern at 1850 MHz of FXUB66 UWB Antenna.

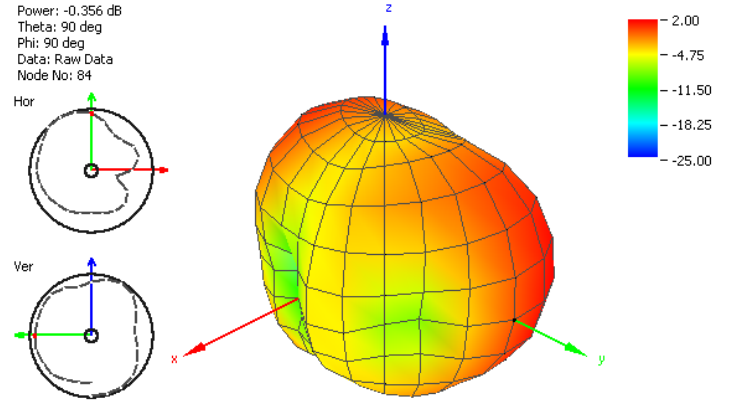

Figure 14. Radiation Pattern at 1950 MHz of FXUB66 UWB Antenna.

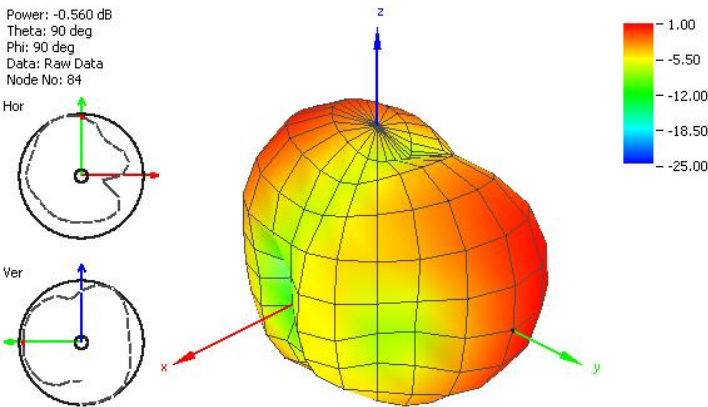

Figure 15. Radiation Pattern at 2100 MHz of FXUB66 UWB Antenna.

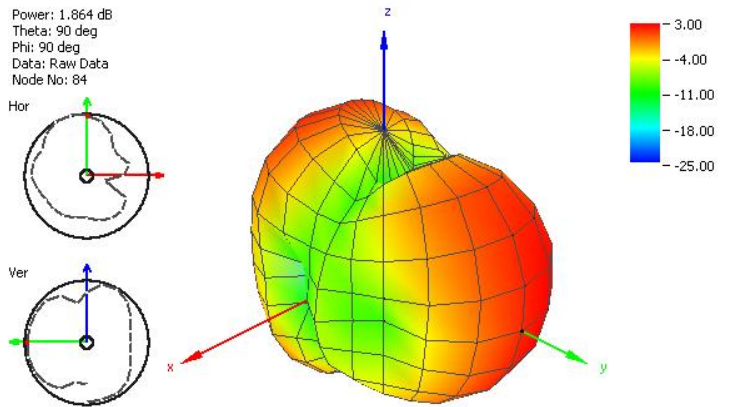

Figure 16. Radiation Pattern at 2450 MHz of FXUB66 UWB Antenna.

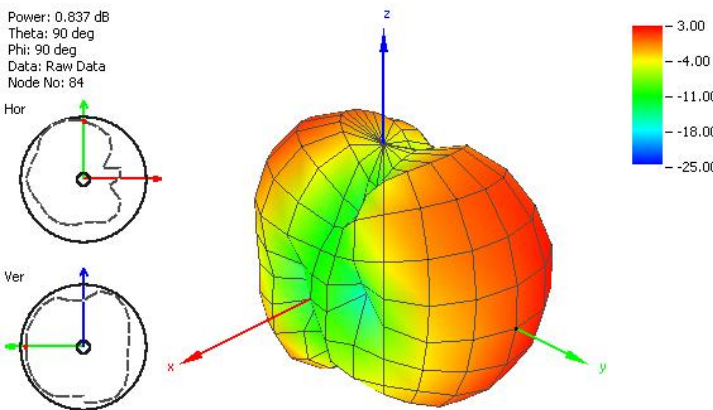

Figure 17. Radiation Pattern at 2600 MHz of FXUB66 UWB Antenna.

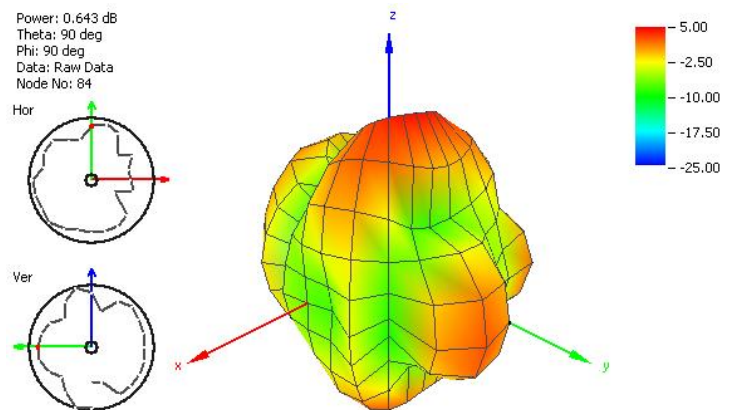

Figure 18. Radiation Pattern at 3600 MHz of FXUB66 UWB Antenna.

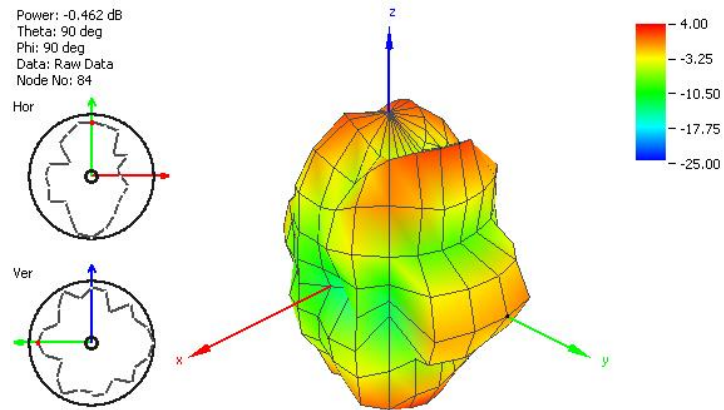
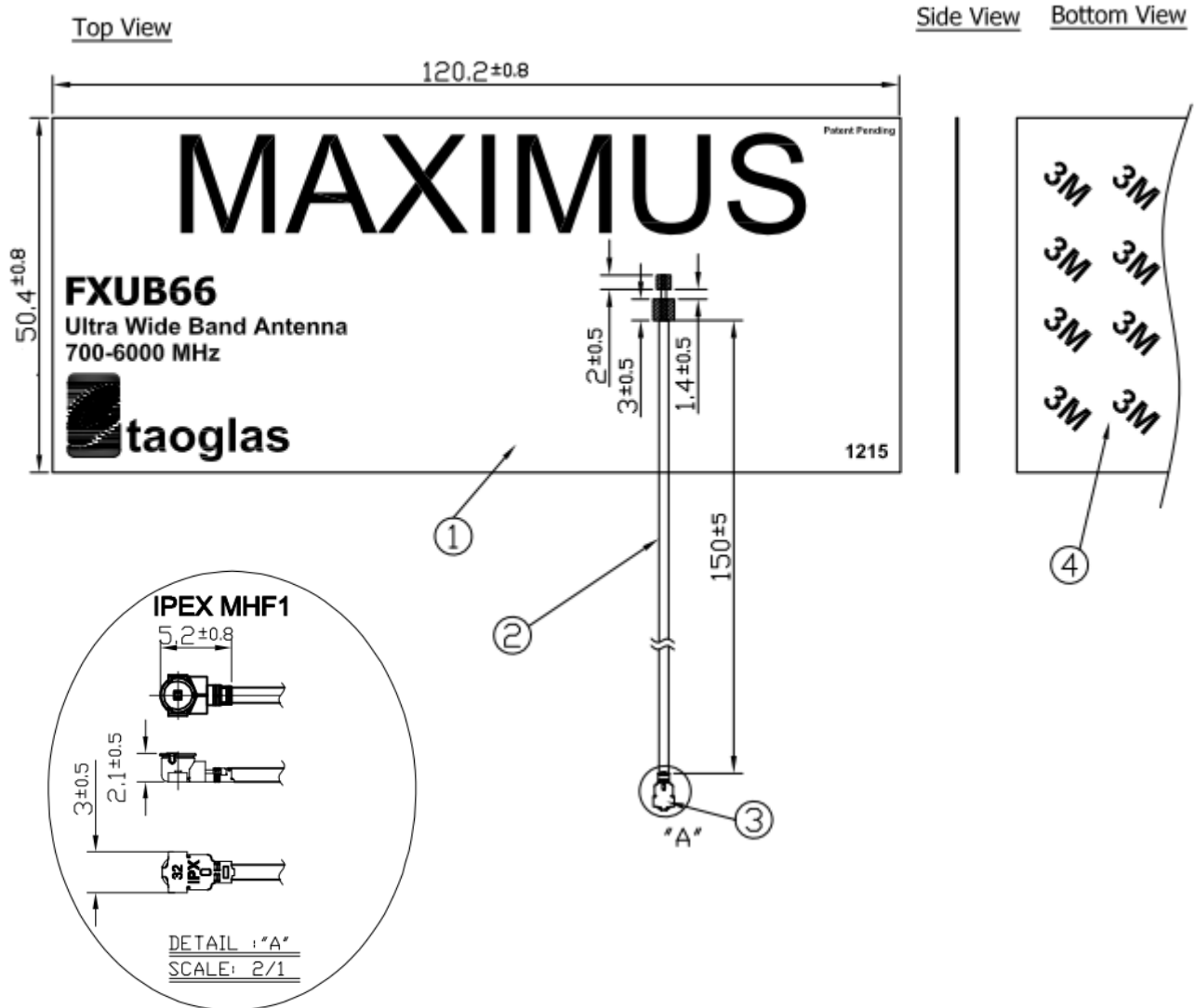

Figure 19. Radiation Pattern at 5500 MHz of FXUB66 UWB Antenna.

5. Mechanical Drawing



	Name	P/N	Material	Finish	QTY
①	FXUB66 FPCB	100112D030012A	FPCB 0.1t	Black	1
②	1.37 Coaxial Cable	OD.137.J	FEP	Black	1
③	IPEX MHF1	IPEX.MHF1.132	Brass	Gold	1
④	Double-Sided Adhesive	100111D0200XXA	3M 467	Brown Liner	1

Figure 20. Mechanical drawing of FXUB66 UWB Antenna.



6. Packaging

100pcs FXUB66.07.0150C per PE Bag
Bag Dimensions - 320 x 200mm
Weight - 380g

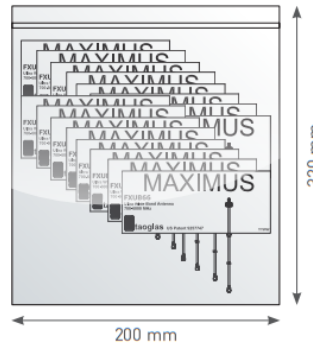
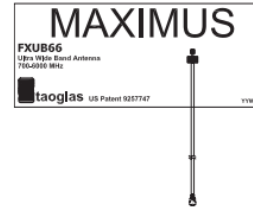

1,000 pcs FXUB66.07.0150C per carton
Carton - 370 x 3200 x 180mm
Weight - 4.01Kg

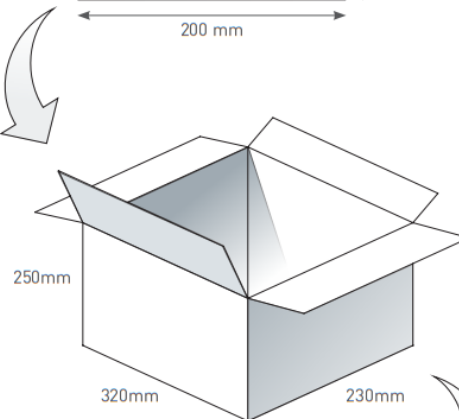

Pallet Dimensions 1200 x 1000 x 1460mm
63 Cartons per Pallet
9 Cartons per layer
7 Layers

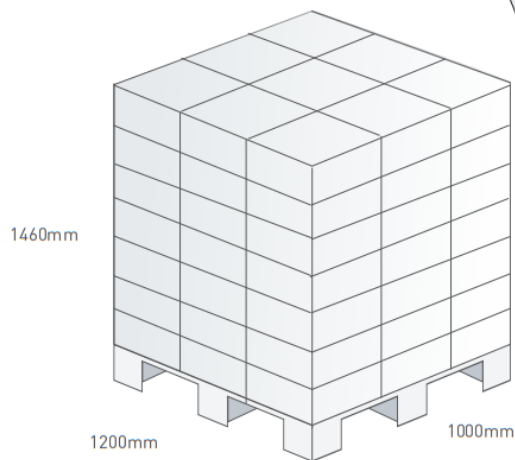



Taoglas makes no warranties based on the accuracy or completeness of the contents of this document and reserves the right to make changes to specifications and product descriptions at any time without notice. Taoglas reserves all rights to this document and the information contained herein.

Reproduction, use or disclosure to third parties without express permission is strictly prohibited.

Copyright © Taoglas Ltd.